

Proportional Directional Control Valve, Pilot Operated

**PRM8-06**

Size 06 (D03) •  $Q_{max}$  140 l/min (37 GPM) •  $p_{max}$  350 bar (5100 PSI)

Technical Features

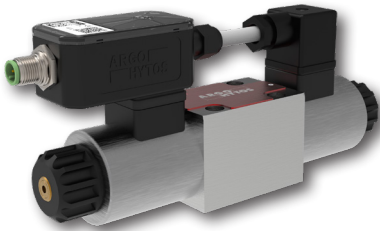

- › Pilot operated proportional directional control spool valve with high hydraulic power
- › Subplate mounting surface acc. to standard ISO 4401 (size 06), DIN 24340 (CETOP 03)
- › The valve is designed for control of movement direction of actuator and continuous speed regulation proportionally to the input command signal
- › Valve control with the help of external or integrated electronic control unit in the form of connector plug
- › Manual override of valve spool
- › Optional type of electric connector for the valve without integrated ECU
- › Adjustable position of coil connector suitable for mounting, achievable by turning the coil after loosening the fastening nut
- › In the standard version, the valve housing is phosphated for basic surface corrosion protection and as preparation for painting. Steel parts are zinc-coated for 240 h salt spray protection acc. to ISO 9227
- › Enhanced surface protection for mobile sector available for the valve housing and steel parts (ISO 9227, 520 h salt spray)

Functional Description

The proportional directional control spool valve is designed to control the movement direction (double solenoid valve), stop, control the speed and position of the piston rod of hydraulic cylinder or shaft of hydraulic motor. The speed of movement is proportional to the volumetric flow through the valve, which is continuously regulated by throttling at the control edges of spool, proportionally to the input command signal. The pilot operated directional control valve has a hydraulically operated main spool, which follows the position of control spool, operated by solenoids. The hydraulic operation of main spool allows to control high hydraulic power because the power characteristic of the valve is unlimited by acting hydrodynamic forces.

The valve can be controlled by electronic control unit EL-7, which converts an input command signal into output PWM current signal for solenoid coils. The electronic control unit EL7 is available as external for connection to a DIN rail (EL7-E, see datasheet HA 9152) or integrated on the valve in a form of connector plug (EL7-I, see datasheet HA 9151).

Technical Data

ISO 4401-03-02-0-05

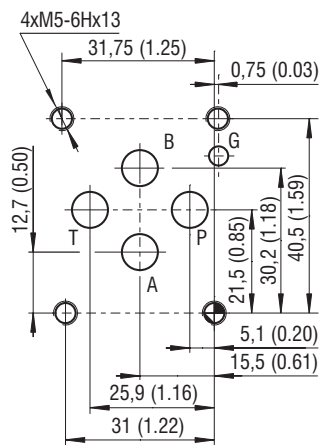

Ports P, A, B, T - max.  $\varnothing$ 7.5 mm (0.29 in)

Valve size	06 (D03)	
Max. operating pressure at ports P, A, B	bar (PSI)	350 (5080)
Maximal flow at pressure 320 bar (4640 PSI)	l/min (GPM)	140 (37)
Max. operating pressure at port T	bar (PSI)	210 (3050)
Fluid temperature range (NBR)	°C (°F)	-30 ... +80 (-22 ... +176)
Fluid temperature range (FPM)	°C (°F)	-20 ... +80 (-4 ... +176)
Ambient temperature range	°C (°F)	-30 ... +50 (-22 ... +122)
Nominal flow rate $Q_n$ at $\Delta p=10$ bar (145 PSI)	l/min (GPM)	25 (6.6)
Hysteresis	%	< 6
Weight	kg (lbs)	2,4 (5.3)
Technical data of proportional solenoid		
Nominal supply voltage	V	12 DC      24 DC
Limit current	A	2,5      1,0
Mean resistance value at 20 °C (68 °F)	$\Omega$	2,3      13,4
Technical data of electronic control unit EL-7		
Operating supply voltage $U_{cc}$	V DC	9 ... 32
Reference voltage $U_{ref}$	V DC	5
Max. current at $U_{ref}$	mA	20
Types of input command signal, when EL7 is used	see datasheet EL7*	
Max. output current / 1 coil	A	3
PWM frequency	Hz	80 ... 1 000
Resolution of A/D converters	bit	12
Ramp function	s	0 ... 45
Dither – amplitude*	% from $I_{max}$	0 ... 30 % from $I_{max}$
Dither – frequency*	Hz	60 ... 300
* When the dither is activated, the PWM frequency is automatically set to 15 kHz		
	Datasheet	Type
General information	GI_0060	products and operating conditions
Coil types / Connectors	C_8007	C22B* / K*
Mounting interface	SMT_0019	Size 06
Spare parts	SP_8010	



**Electronic control unit EL7**

The ECU EL7 allows direct independent control of the valve with an analogue input command signal or connection of the valve to the CANBus control system of machine.

**Proportional valve with external electronic control unit EL7-E**

The valve can be controlled by external ECU EL7-E designed for connection to a DIN rail. The user electrically connects the ECU to the valve with a cable. The ECU EL7-E can be used for control of one solenoid or two solenoid valves. Selection and setting of ECU parameters is described in **datasheet HA 9152**

**Valve with one solenoid and integrated ECU EL7-I\*-1**

The ECU in the form of connector plug is simply mounted on the socket of connector EN 175301-803-A of solenoid coil and fastened with a fixing screw.

**Valve with two solenoids and integrated ECU EL7-I\*-2-105**

The ECU in the form of connector plug is simply mounted on the socket of connector EN 175301-803-A of solenoid coil and fastened with a fixing screw. The second solenoid is connected to the ECU with a cable. If the integrated ECU EL7-I is ordered separately, the length of cable must be specified. The length of cable is defined as a distance between fastening screws of ECU and connector plug. Selection and setting of ECU parameters is described in **datasheet HA 9151**

**Solenoid Coil** in millimeters (in)

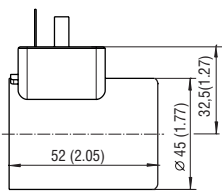
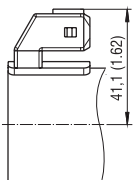
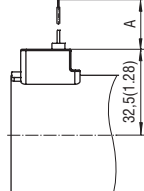
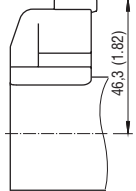
E1, E2 Protection Degree IP65	E3A, E4A Protection Degree IP67	E8, E9	E12A, E13A Protection Degree IP67 / 69K
		 <p>Note: A = Standard 300 mm (11.8 in), other lengths on demand</p>	

The indicated IP protection level is only achieved if the connector is properly mounted.

**Manual Override** in millimeters (in)

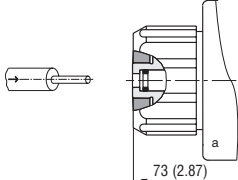
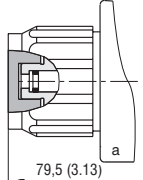
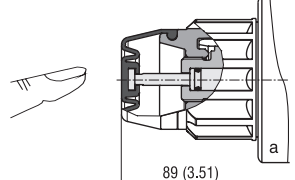
No Designation - Standard (operated by pin)	Designation N1 - Cap Nut Covered	Designation N2 - Rubber Boot Protected
		

In case of solenoid malfunction or power failure, the spool of valve can be shifted with a manual override under condition that the P channel is pressurized. The main spool is operated hydraulically after shifting the control spool with the manual override. The pressure in T port does not exceed 25 bar (363 PSI). For alternative manual overrides contact our technical support.

**Dimensions** in millimeters (in)

**PRM8-063.../...E1**

Valve with two solenoids  
Example with electrical terminal  
EN 175301-803-A (E1, E2)

Spool type  
3Z11, 3Y11, 3Y21

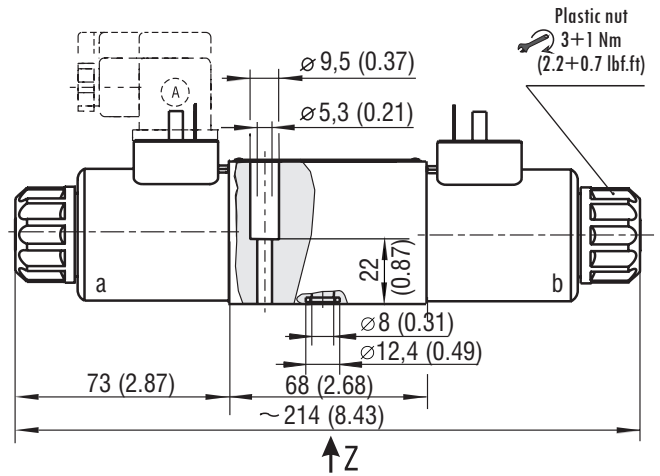
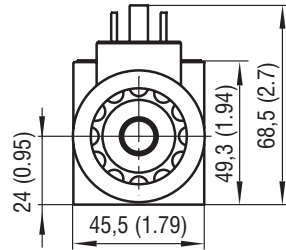
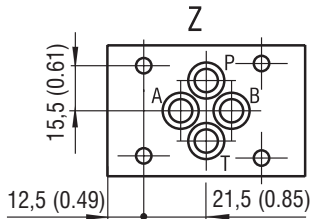

**PRM8-062.../...E1**

Valve with one solenoid "b"  
Spool type 2Z11

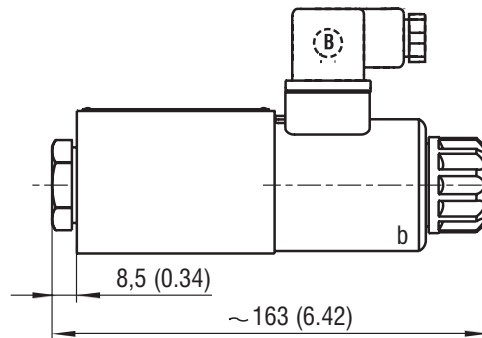

**PRM8-063\*/...-EL7\*...**

Valve with two solenoids and integrated electronic control unit EL-I\*-2-105

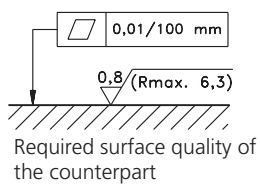
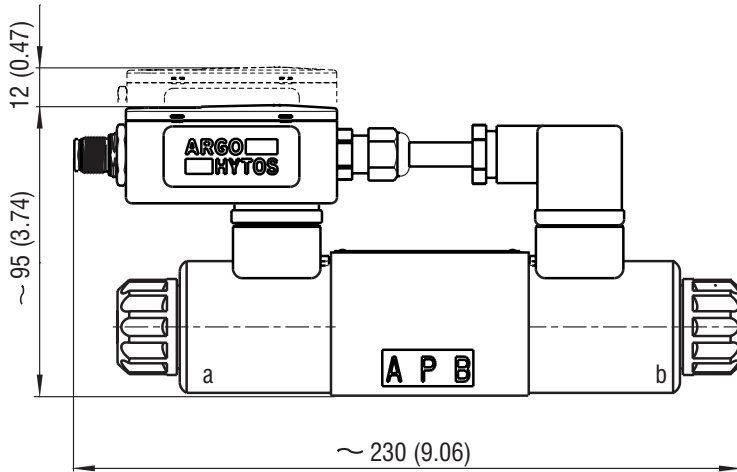

**i** Proper function of the valve is guaranteed only if the supply pressure in the "P" channel is present and exceeds always the pressure in the "T" channel.