

Pressure Relief Valve, Spool Type, Pilot Operated, External Pilot and Drain

VPN1-06/S

M22 x 1.5 • Q_{max} 70 l/min (18.5 GPM) • p_{max} 320 bar (4600 PSI)

Model S

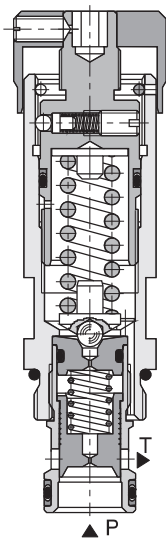

Model SX (SY)

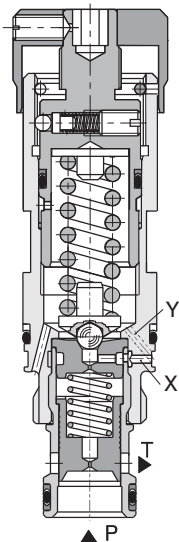

Technical Features

- › Excellent stability throughout flow range with rapid response to dynamic pressure changes
- › Low hysteresis, accurate pressure control and low pressure drop
- › Wide pressure range up to 320 bar
- › High flow capacity
- › Hardened precision parts
- › Ideal for use as control valve where accuracy and repeatability is required
- › External pilot and drain option
- › Adjustable by allen key or hand screw, optionally sealable (lockwire holes)
- › In the standard version, the valve is zinc-coated for 240 h protection acc. to ISO 9227

Functional Description

A pilot operated, spool type hydraulic relief valve in the form of a screw-in cartridge intended for use as a pressure limiting device. Fast-acting with low hysteresis. Because of the absence of any internal seals, the valve shows excellent reseating and repeatability characteristics. It may be used as a main pressure control element but due to its two stage design it is not recommended for safety applications where operating speed is critical. Version SX has an external pilot line, version SY allows a separate drain connection.

Model	S	SX	SY
Symbol			

Technical Data

Valve size / Cartridge cavity		M22 x 1.5 / QG2	M22 x 1.5 / QF2
Model		S	SX, SY
Max. flow	l/min (GPM)	70 (18.5)	
Max. operating pressure	bar (PSI)	320 (4640)	
Fluid temperature range (NBR)	°C (°F)	-30 ... +100 (-22 ... 212)	
Fluid temperature range (FPM)	°C (°F)	-20 ... +120 (-4 ... 248)	
Weight	kg (lbs)	0.25 (0.55)	
		Datasheet	Type
General information		GI_0060	Products and operating conditions
Valve bodies	In-line mounted	SB_0018	SB-QG2*
	Sandwich mounted	SB-04(06)_0028	SB-*QG2*
Cavity details		SMT_0019	SMT-QG2*
Spare parts		SP_8010	

Characteristics measured at v = 32 mm²/s (156 SUS)

Relief pressure related to flow rate

Model S, SX

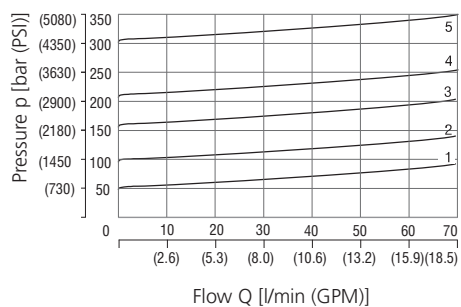

	Pressure range
5	32
4	21
3	16
2	10
1	6

Relief pressure related to flow rate

Model SY

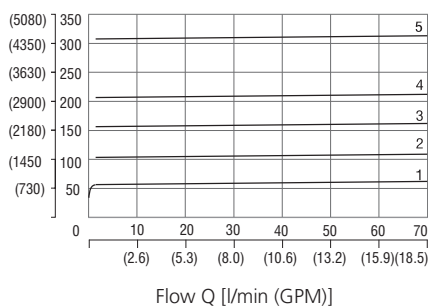

	Pressure range
5	32
4	21
3	16
2	10
1	6

Minimum set and circulation pressure

Model S, SX, SY

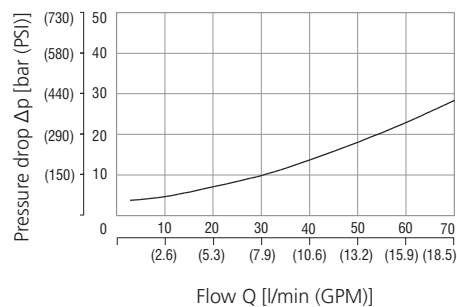

Dimensions in millimeters (inches)

VPN1-06/S

Model S

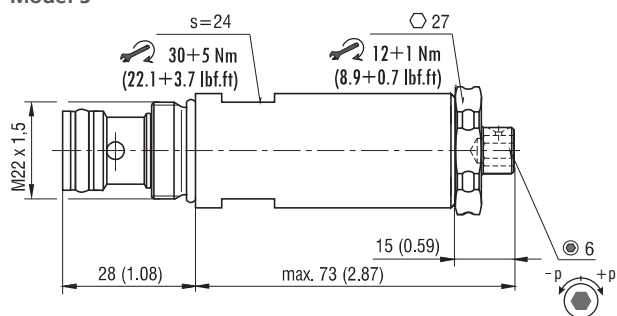

Model T

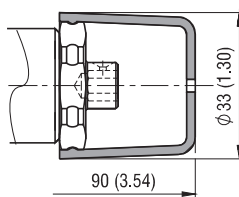

Model RS

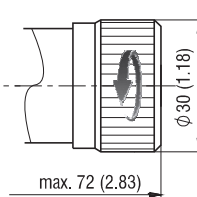

Model RP

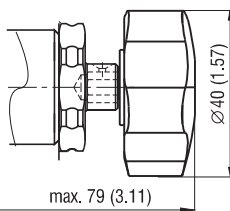

Model L

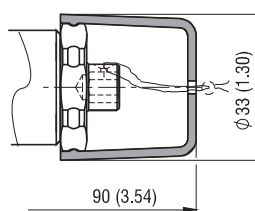

VPN1-06/SX (SY)

Model S

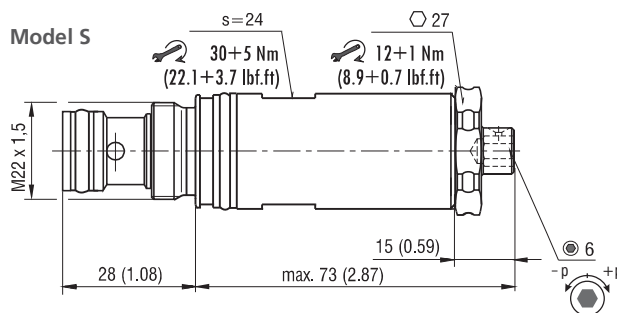

Model T

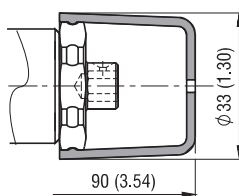

Model RS

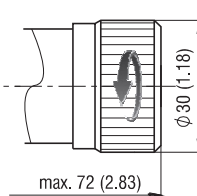

Model RP

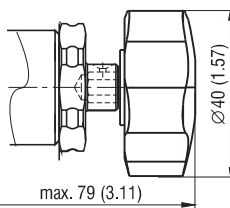

Model L

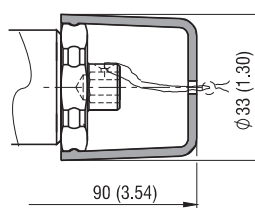

Ordering Code

VPN1-06 / [] - [] [] [] - []

Pressure relief valve, spool type,
pilot operated,
external pilot and drain M22 x 1.5

Model
internal pilot and drain S
external pilot, internal drain SX
internal pilot, external drain SY

Pressure range
up to 63 bar (910 PSI) 6
up to 100 bar (1450 PSI) 10
up to 160 bar (2320 PSI) 16
up to 210 bar (3050 PSI) 21
up to 320 bar (4600 PSI) 32

Surface treatment
A zinc-coated (ZnCr-3), ISO 9227 (240 h)
B zinc-coated (ZnNi), ISO 9227 (520 h)

No designation V

Seals
NBR
FPM (Viton)

Adjustment option
allen key (hex. 6), without protective cap
allen key (hex. 6), with protective cap
hand screw, metal
hand screw, plastic
allen key (hex. 6), with protective cap, sealable (lockwire holes)